



Warning: The contents of this manual shall not be modified without consent. Our company reserves the right to change the products in terms of technology, parts and components, software and hardware. The users may contact the distributor for further information about the products. Without permission, none of the sections of this manual shall be reproduced or transmitted in any form or by any means whatsoever.

Thermal Transfer Printer

4B-2044PA

Portable Barcode Printer

User's Manual of Standard Version

Please keep the user's manual properly for reference

Contents

I. Overview	1
1.1 Introduction	1
1.2 Parameters of product	2
1.3 General specification	3
1.4 Printing specification	3
1.5 Paper specification	4
II. Product	5
2.1 Unpacking and inspection	5
2.2 Printer components	6
III. Installation	9
3.1 Install the printer	9
3.2 Install the paper roll	10
It is recommended that you shall calibrate the sensor again when you replace with different types of label paper.	10
IV. Display Screen and Button Functions	11
4.1 Button names and display screen:	11
4.2 Power-on function	11
4.3 Switching between barcode/bill mode	15
V. LCD Operation Panel	16
5.1 Setting	17
5.2 File management	24
5.3 Printing debugging	26
5.4 Language	26
5.5 Printer information	27
VI. Diagnostic Tool	28
6.1 Enable the Diagnostic Tool program	28
6.2 Printer settings	29
6.3 Calibrate the paper sensor with the Diagnostic Tool	30
VII. Troubleshooting	31
7.1 Common problems	31
VIII. Simple Maintenance of the Printer	34
Update history	35

Copyright statement

Information in this subject to change without notice and does not represent a commitment on the part. No part of this manual may be reproduced or transmitted in any form by any means, for any purpose other than the purchaser's personal use, without the expressed written permission. The picture below is for reference only, and the appearance is subject to the product purchased.

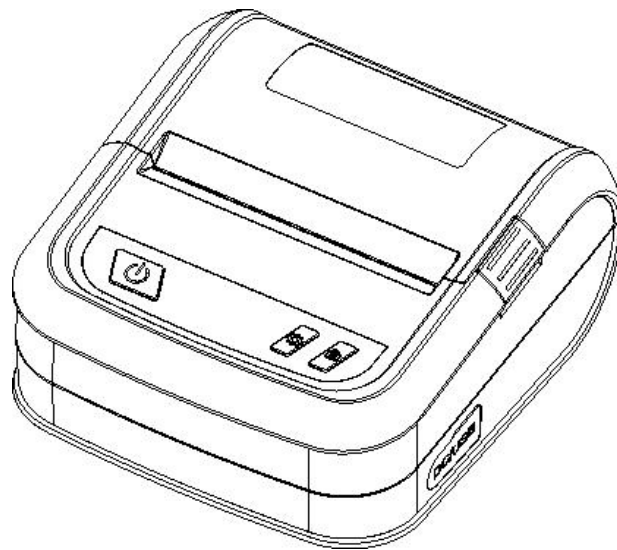

I. Overview

1.1 Introduction

Thank you for purchasing the portable barcode printer made by our company.

This model simultaneously supports two modes including labels and bills, so as to deal with different usage scenarios. In addition, this model has a built-in high-quality and efficient “True Type Font” engine and font library. With a flexible design of firmware, the users can also download the True Type Font from the computer into the printer’s memory. In addition to the ability to zoom the fonts, there are five different sizes of bitmap font, OCR-A and OCR-B fonts. Integrated with such powerful functions, affordable price, and the best printing quality, this printer will be your best choice for portable barcode printers at the same level.

Please refer to the information provided by your volume label editing software when printing the label format. If you need to write your own instruction program, please refer to the instruction manuals for TSPL, ZPL, DPL, EPL, CPCL, and ESC/POS.

Scope of application

- o Manufacturing & warehousing logistics
 - Volume label of manufacturing mark
 - Label of inventory management
 - Label of item mark
 - Label of operation instruction
 - Label of distribution instruction
- o Medical care
 - Identification of patients
 - Medicine mark
 - Label of specimen
- o Parcel mailing
 - Label of posting/receipt
- o Small office/studio
- o Retail
 - Price mark
 - Shelf item mark
 - Volume label of jewelry product

1.2 Parameters of product

Standard configuration

Standard configuration of product	203 dpi
Thermal printing	○
Two-color plastic case	○
Adjustable gap sensor/penetration type	○
Adjustable black mark sensor/reflection type	○
Printhead open sensor	○
USB 2.0 communication interface	○
8 MB SDRAM memory	○
8 MB FLASH memory	○
Date/time generator	○
Paper-out button and LCD display	○
Supporting programming languages of barcode printers of other brands (Eltron® and Zebra®)	○
Supporting bill instructions	○
Containing 8 kinds of bitmap English digital types	○
Printing out fonts and barcodes rotationally in four directions (0, 90,180, 270 degrees)	○
Containing fonts	○
Downloading Windows fonts for use	○
Downloading firmware updates	○
Printing text, barcode, image/picture (for those supporting code page, please refer to the instructions manual of TSPL)	○

Supported barcodes		Supported formats of pictures
1D bar code	2D bar code	
Code 39, Code 93, Code128UCC, Code128 subsets A, B, C, Codabar, Interleaved 2 of 5, EAN-8, EAN-13, EAN-128, UPC-A, UPC-E, EAN and UPC 2(5) digits add-on, MSI, PLESSEY, POSTNET, China POST, GS1 DataBar, Code 11	PDF-417, Maxicode, DataMatrix, QR code, Aztec, GS1 DataBar Composite code	BITMAP, BMP, PCX (Max. 256 colors graphics)

Optional accessories

Optional accessories of product	Optional by customer	Optional by distributor	Optional by manufacturer
Wireless network communication interface	-	-	○

1.3 General specification

General specification	
Volume and dimensions of printer	150 mm (D) x 131 mm (W) x64 mm (H)
Weight of printer	0.583 kg
Power supply	Internal voltage automatic switching power supply Input: AC 110-240V Output: 18W/DC 5V 2A, 10W (Specific in kind)
Environmental conditions	Operation environment: Temperature 5 ~ 40°C (41 ~ 104°F); humidity (non-condensing) 25~85% Storage environment: Temperature -40 ~ 60°C (-40 ~ 140°F); humidity (non-condensing) 10~90%

1.4 Printing specification

Printing specification	203 dpi
Resolution of print head	8 dots/mm (203 dots/inch)
Printing mode	Direct Thermal
Dot size (Width x Length)	0.125 x 0.125 mm (1 mm = 8 dots)
Printing speed (ips: inch/second)	4B-2044PA: 1, 2, 3,4 ips (1 ips = 25.4mm/s)
Maximum printing width	104 mm (4.09")
Maximum printing length	1778 mm (70")

1.5 Paper specification

Paper specification	203 dpi
Paper bin capacity	50 mm OD
Type of paper	Continuous paper, gap paper, black mark paper, perforated paper
Winding type of paper	Outward winding of printing surface
Width of paper (label + body paper)	Maximum 112 mm
	Minimum 40mm
Thickness of paper (label + body paper)	Maximum 0.16 mm
	Minimum 0.06 mm
Axis size of paper roll	12.7 mm~25.4 mm (0.5"~1")
Length of label	10~1778 mm (0.39"~70")
	Remark: If you are using a label in the length less than 25.4mm (1"), it is recommended to use a label paper with perforated lines on the gap so as to tear apart easily.
Spacing height of gap paper	Minimum 2 mm (0.09")
Black mark height of black mark paper	Minimum 2 mm (0.09")
Black mark width of black mark paper	Minimum 8 mm (0.31")

II. Product

2.1 Unpacking and inspection

This printer is specially packaged to protect against possible damage in transit. However, since the printer may still be subjected to unexpected damage during transportation, you are kindly required to check the packaging and all units carefully when receiving the printer. In case of obvious damage, please contact the sales dealer directly and indicate the severity of the damage. Please keep the packaging materials for returning the printer.

Once you have received your barcode printer, place it on a clean, steady table and carefully remove the packaging materials. Check if the following items are included:

- One barcode printer
- One installation driver CD-ROM
- One copy of operation instructions
- One Type C data cable
- One power adapter
- One set of paper roll supply shaft



Printer

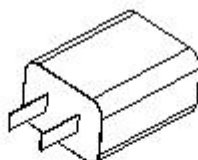

Power adapter



CD



Battery



USB Type-C cable



Quick Start Guide

Please keep the printer's packaging materials properly for future handling. In case of any shortage or missing of the aforesaid items, please contact the customer service department in the place where you purchased the printer.

2.2 Printer components

Appearance

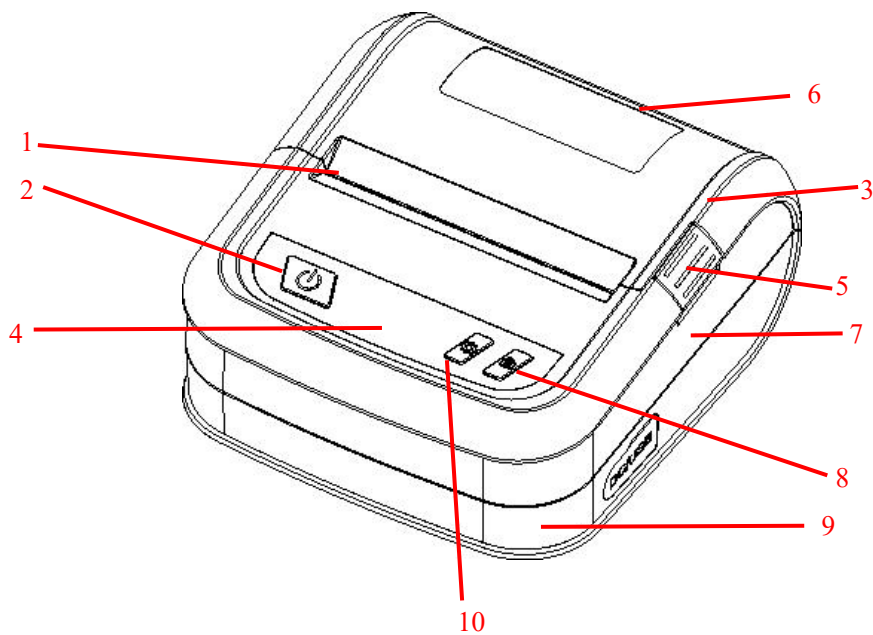

1. Paper exit
2. Power on/off button
3. Clamshell
4. Display screen
5. Clamshell switch
6. Transparent clamshell lens
7. Medium frame
8. Paper feeding button
9. Base
10. Menu button

Interior

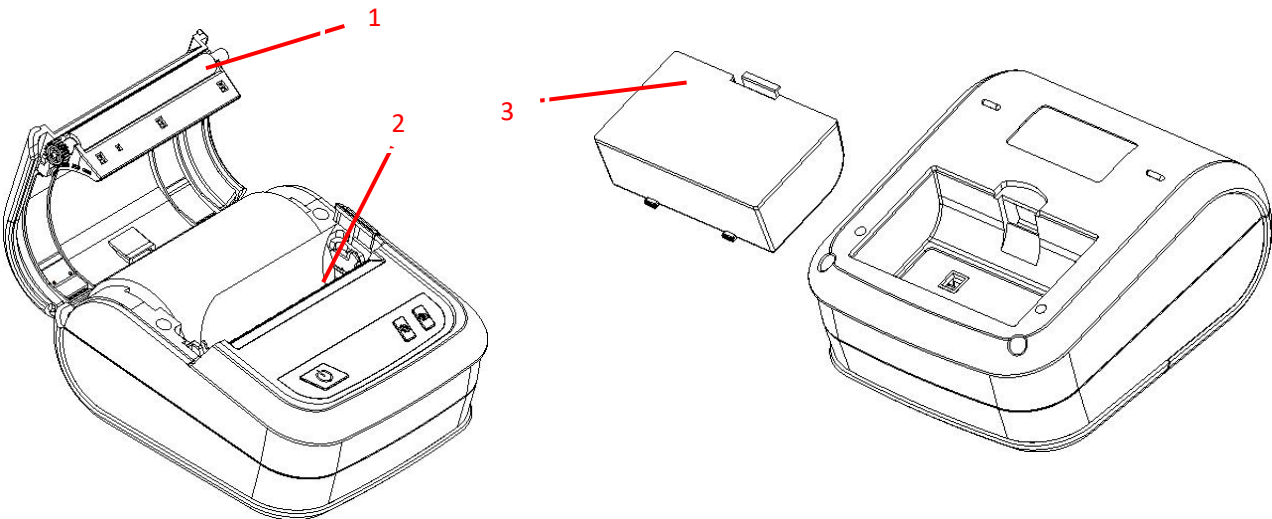

- 1. Printing rubber roller
- 2. Print head
- 3. Battery

Side

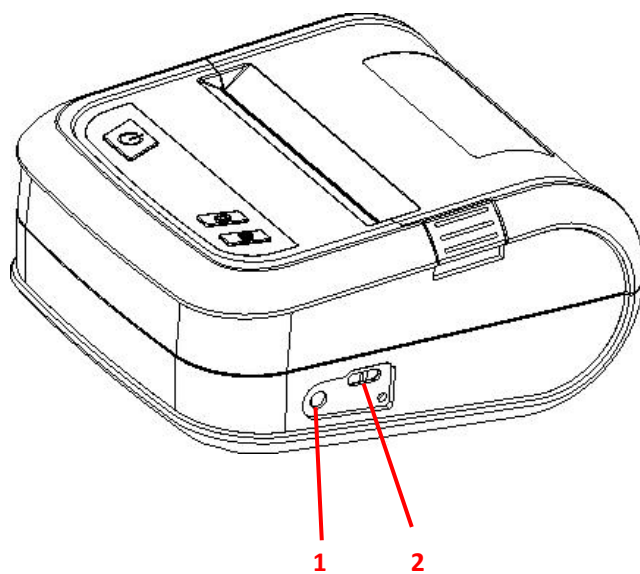

1. Power interface
2. Type C interface

Note: The transmission interface of the printer as shown in the picture will vary depending on the type of the printer purchased by you. Please refer to the catalog and specification of the product for the actual transmission interface.

III. Installation

3.1 Install the printer

1. Connect the adapter cable to the power interface of the printer.
2. Connect the interface cable to the user's equipment. (Connect to the printer via mobile phone Bluetooth / WIFI)

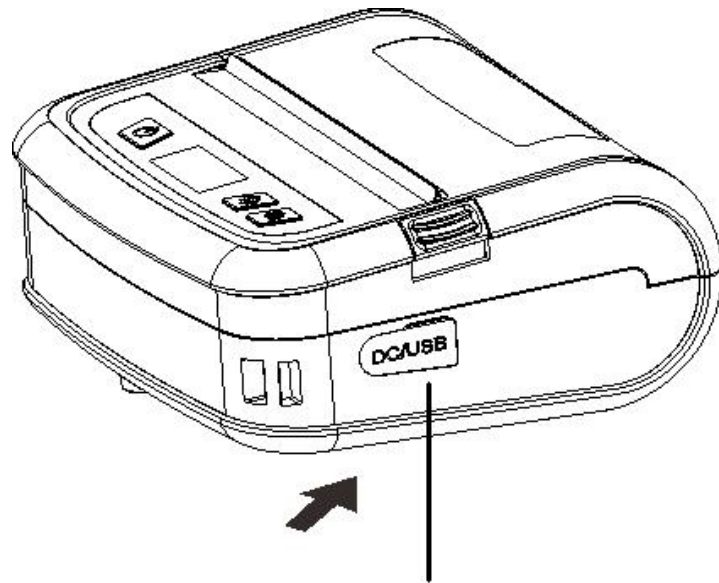

Power interface/Type C interface

Note:

- * Please turn off the power switch of the printer, and insert the power cable into the power socket of the printer.
- * The transmission interface of the printer as shown in the picture will vary depending on the type of the printer purchased by you. Please refer to the catalog and specification of the product for the actual transmission interface.

3.2 Install the paper roll

3.2.1 Install the paper roll

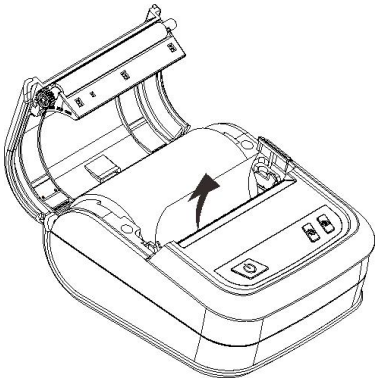
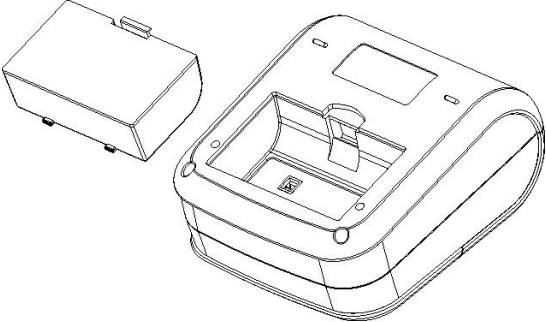
	<p>1. When installing the printing paper roll, put the paper roll into the label supply shaft and use the paper roll fixing sheet to fix the paper roll at the supply shaft position.</p>
	<p>2. Installation of battery. (Remove the battery protective film before use; otherwise, the battery will not provide the power or the printer will not be turned on.)</p>

Note: This series of paper sensors are stationary on the left side. Please make sure that the gap (or black mark) of the paper passes through the sensor.

It is recommended that you shall calibrate the sensor again when you replace with different types of label paper.

IV. Display Screen and Button Functions

4.1 Button names and display screen:

(1) POWER button

A. Power-on: In the power-off state, press and hold the POWER button for 2S, and the printer enters the working state.

B. Power-off: In the power-on state, press and hold the POWER button for 2S, and the printer is power off.

C. Forced power-off: If an unknown error occurs to the printer, press and hold the POWER button for 6S to power off forcibly.

D. Return to menu: In the menu open state, press the POWER button to return to the previous menu.

(2) MENU button

A. Menu opening: The standby state is displayed on the display screen; press the MENU button to enter the menu.

B. Option determination: In the menu open state, press this button to determine the options.

(3) FEED button

A. Paper feeding function: Press this button to feed a piece of paper.

B. Scroll-down function: In the menu open state, press this button to select scroll-down.

(4) Display screen

The state of printer, capacity of battery, and other messages can be displayed on the display screen.

4.2 Power-on function

This printer has the following power-on functions, which can be used to set up or test the printer hardware. To enable these functions, press the POWER button while holding down the FEED button, release the POWER button when the screen lights up, and release the FEED button according to the displayed message.

Power-on function	Displayed message
Detection by gap/black mark sensor	Calibrate
Detection by gap/black mark sensor, printing of self-test page, and entry into debugging mode	Self Test
Initialization of printer	Initialize
Detection by black mark sensor	Blind Detect
Detection by gap sensor	Gap Detect
Skip AUTO.BAS program	Enter the standby interface

4.2.1 Detection by gap/black mark sensor

This test is used to measure the sensitivity of the label paper sensor after the printer is turned on. It is required to retest the label paper gap sensor when the user replaces with the new paper roll in different specifications or initializes the printer and restores the set

values to the factory default values.

4.2.2 Detection by gap/black mark sensor, printing of self-test page, and entry into debugging mode

By this test, the sensor will be calibrated first after the printer is powered on, and the internal set values of the printer will be printed, and the printer will enter the debugging mode.

Self-test

When the sensor calibration is completed, the printer prints out the self-test value. Before connecting the printer to your computer, you can use self-test to confirm that the printer is functioning properly. The printed self-test value can be used to check the printing quality of the print head and know the internal settings of the printer.

Internal settings of printer printed in the self-test mode

<pre> PRINTER INFO. XXXXXXXX Version: 1.014 EZ SERIAL NO. :XXXXXXXXXXXXXX MILAGE(m) : 0 CHECKSUM: 06BA1827 SERIAL PORT: 9600,N,8,1 CODE PAGE: 850 COUNTRY CODE: 001 SPEED: 5 INCH DENSITY: 8.0 SIZE: 4.00 , 4.00 GAP: 0.00 , 0.00 TRANSPARENCE: 7 ***** FILE LIST: DRAM FILE: 0 FILE(S) FLASH FILE: 0 FILE(S) PHYSICAL DRAM: 8192 KBYTES AVAILABLE DRAM: 256 KBYTES FREE PHYSICAL FLASH: 4096 KBYTES AVAILABLE FLASH: 2560 KBYTES FREE END OF FILE LIST ***** NOW IN DUMP MODE </pre>	<p>Print head check sample</p> <p>Model & firmware version</p> <p>Machine serial number</p> <p>Print head mileage</p> <p>Check code</p> <p>Serial port setting</p> <p>Character set</p> <p>Country code</p> <p>Printing speed</p> <p>Printing density</p> <p>Paper size (width, height)</p> <p>Black mark or gap size (vertical gap, offset)</p> <p>Sensor strength</p> <p>Stored file information</p>
---	--

Debugging mode

After the self-test is printed, the printer system enters the debugging mode. In the debugging mode, all the volume labels will be printed in machine code. The ASCII strings on the left are the data received by the system. The data on the right are printed from the strings on the left, in hexadecimal values. This function is provided for users or engineers to debug programs. You only need to turn off and on the power again to leave the debugging mode and return to the normal printing mode.

ASCII string



mm GAP 4 mm	BD	BD	0D	0A	47	41	50	20	34	20	6D	6D
0 mm SET	2C	20	30	20	6D	6D	0D	0A	53	45	54	20
RIBBON OFF	52	49	42	42	4F	4E	20	4F	46	46	0D	0A
DIRECTION 0,	44	49	52	45	43	54	49	4F	4E	20	30	2C
0 REFERENCE	30	0D	0A	52	45	46	45	52	45	4E	43	45
0,0 OFFSET	20	30	2C	30	0D	0A	4F	46	46	53	45	54
0 mm SET P	20	30	20	6D	6D	0D	0A	53	45	54	20	50
EEL OFF SET	45	45	4C	20	4F	46	46	0D	0A	53	45	54
CUTTER OFF	20	43	55	54	54	45	52	20	4F	46	46	0D
SET TEAR ON	0A	53	45	54	20	54	45	41	52	20	4F	4E
CLS BAR 2	0D	0A	43	4C	53	0D	0A	42	41	52	20	32
02,810, 406,	30	32	2C	38	31	30	2C	20	34	30	36	2C
2 BAR 203,	20	32	0D	0A	42	41	52	20	32	30	33	2C
608, 2, 203	36	30	38	2C	20	32	2C	20	32	30	33	0D
BAR 202,609	0A	42	41	52	20	32	30	32	2C	36	30	39
, 406, 2 BA	2C	20	34	30	36	2C	20	32	0D	0A	42	41
R 607,608, 2	52	20	36	30	37	2C	36	30	38	2C	20	32
, 203 BAR 2	2C	20	32	30	33	0D	0A	42	41	52	20	32
08,804, 394,	30	38	2C	38	30	34	2C	20	33	39	34	2C
2 BAR 209,	20	32	0D	0A	42	41	52	20	32	30	39	2C
614, 2, 191	36	31	34	2C	20	32	2C	20	31	39	31	0D
BAR 208,615	0A	42	41	52	20	32	30	38	2C	36	31	35
, 394, 2 BA	2C	20	33	39	34	2C	20	32	0D	0A	42	41
R 601,614, 2	52	20	36	30	31	2C	36	31	34	2C	20	32
, 191 BAR 5	2C	20	31	39	31	0D	0A	42	41	52	20	35
06,761, 82,	30	36	2C	37	36	31	2C	20	38	32	2C	20
10 BAR 543,	31	30	0D	0A	42	41	52	20	35	34	33	2C
649, 10, 121	36	34	39	2C	20	31	30	2C	20	31	32	31
BAR 415,76	0D	0A	42	41	52	20	34	31	35	2C	37	36
1, 71, 10 B	31	2C	20	37	31	2C	20	31	30	0D	0A	42
AR 425,705,	41	52	20	34	32	35	2C	37	30	35	2C	20
61, 11 BAR	36	31	2C	20	31	31	0D	0A	42	41	52	20
415,650, 71,	34	31	35	2C	36	35	30	2C	20	37	31	2C
10 BAR 477	20	31	30	0D	0A	42	41	52	20	34	37	37
, 649, 10, 12	2C	36	34	39	2C	20	31	30	2C	20	31	32
1 BAR 324,7	31	0D	0A	42	41	52	20	33	32	34	2C	37
61, 71, 10	36	31	2C	20	37	31	2C	20	31	30	0D	0A
BAR 324,705,	42	41	52	20	33	32	34	2C	37	30	35	2C
71, 11 BAR	20	37	31	2C	20	31	31	0D	0A	42	41	52
324,650, 71	20	33	32	34	2C	36	35	30	2C	20	37	31
, 10 BAR 38	2C	20	31	30	0D	0A	42	41	52	20	33	38
6,704, 10, 6	36	2C	37	30	34	2C	20	31	30	2C	20	36
6 BAR 325,6	36	0D	0A	42	41	52	20	33	32	35	2C	36
49, 10, 66	34	39	2C	20	31	30	2C	20	36	36	0D	0A
BAR 222,761,	42	41	52	20	32	32	32	2C	37	36	31	2C
81, 10 BAR	20	38	31	2C	20	31	30	0D	0A	42	41	52
259,649, 10	20	32	35	39	2C	36	34	39	2C	20	31	30
, 121 PRINT	2C	20	31	32	31	0D	0A	50	52	49	4E	54
1,1	20	31	2C	31	0D	0A						

Hexadecimal value data corresponding to the ASCII string listed on the left

Note:

1. Label paper of **3"** wide is required to print all the debugging mode data.
2. Turn off and on the power to leave the debugging mode and return to the normal printing mode, or press the **FEED** button to return to the standby state.

4.2.3 Printer initialization

The printer initialization function is to clear the downloaded files in the memory (DRAM) and restore the print parameters to the factory default settings. After enabling the printer initialization function, the printer will reset.

After initialization, the printer configuration is restored to its default values as follows:

Parameters	Defaults
Speed.	76 mm/sec (3 ips) (203DPI)
Density	8
Label width	2.83" (72 mm)
Label height	4.0" (108 mm)
Sensor type	Gap sensor
Gap setting	0.12" (3.0 mm)
Printing direction	0
Reference point	0,0
Offset	0
Tear-off mode	On
Characters	850
Country code	001
Clear flash	No

4.2.4 Skip the AUTO.BAS program

The XPL programming manual command language allows the user to load an auto-execute file (AUTO.BAS) into the flash memory. When the printer is turned on, it will be automatically executed according to the file loaded by the user. When you want to skip the AUTO.BAS after power-on, you can use this boot function to ignore this auto-execute file.

4.3 Switching between barcode/bill mode

1) Barcode mode --> bill mode:

Enter the main menu -> Set -> Print the settings -> Instruction mode -> Select ESCPOS.

The printer is automatically restarted, and ESC is displayed at the top right of the standby interface; at this time, the printer switches to the bill mode.

2) Bill mode --> barcode mode:

Press and hold the POWER button first, then press the MENU button or the FEED button, and then release all the buttons, and the printer is restarted automatically, and EZD is displayed at the top right of the standby interface; at this time, the printer switches to the barcode mode.

V. LCD Operation Panel

The LCD display screen version of this printer has four operation buttons including menu, scroll up, scroll down, and feed; the menu button and feed button shall be used as the OK button and backspace button respectively after entering the menu.

List of Main Menu Functions

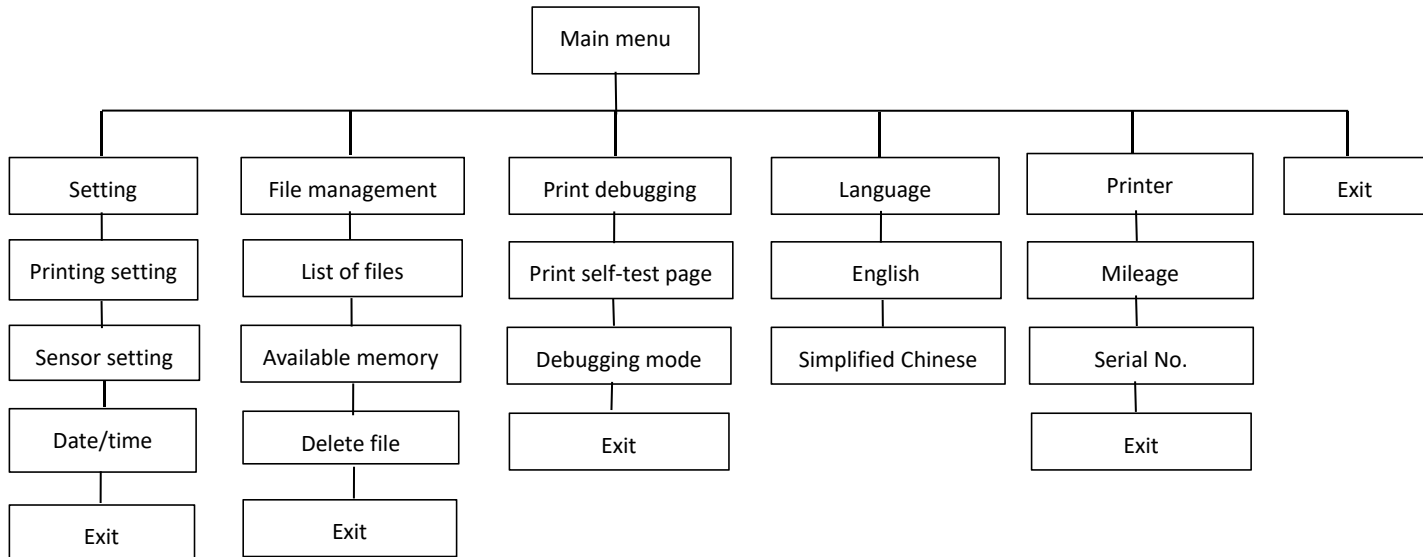

5.1 Setting

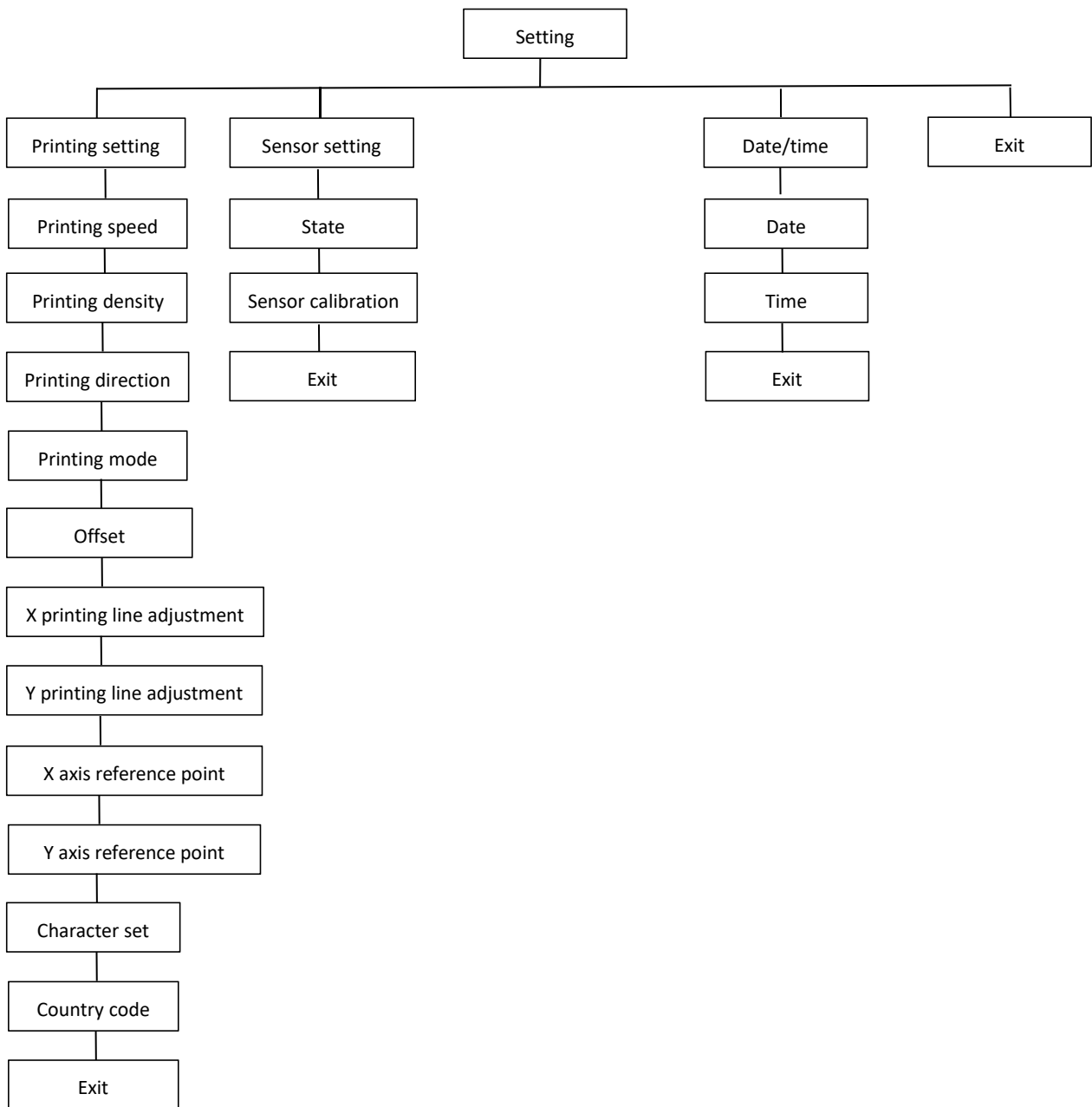

5.1.1 Printing setting

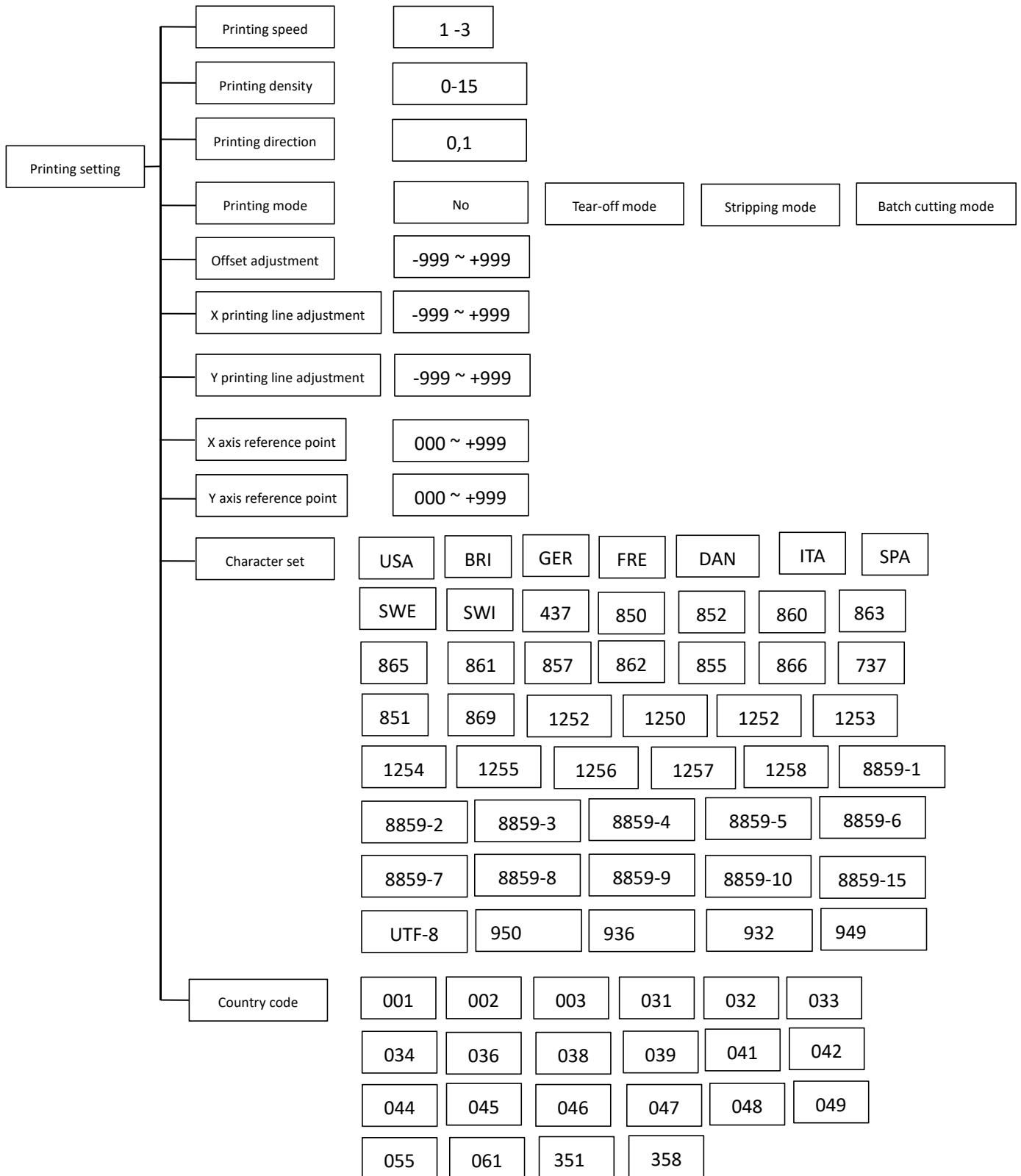

5.1.1- 1.1 Setting of printing speed



Use this option to set the printing speed of the printer. The adjustment ranges from 1 to 3 ips; The gap of increase and decrease is 1 ips each time.

Press FEED to select the value.

Press MENU to confirm the setting.

Press POWER to cancel the setting and return to the previous menu.

5.1.1 - 1.2 Printing density

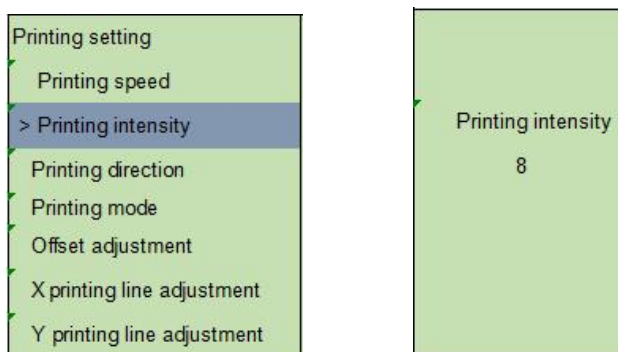

Use this option to set the printing density of the printer. The adjustment ranges from 0 to 15; The gap of increase and decrease is 1 each time.

Press FEED to select the value.

Press MENU to confirm the setting.

Press POWER to cancel the setting and return to the previous menu.

5.1.1 - 1.3 Printing direction

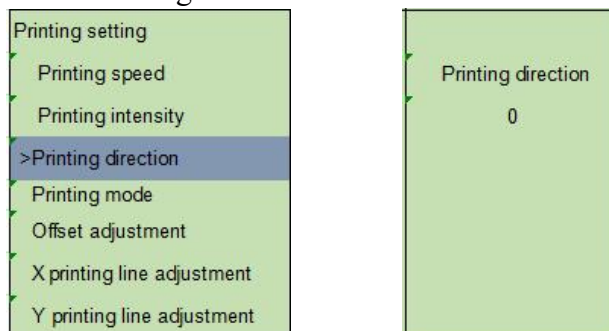

Use this option to set the printing direction of the printer. The set value of the printing direction is 1 or 0.

Press FEED to adjust the value.

Press MENU to confirm the setting.

Press POWER to cancel the setting and return to the previous menu.

5.1.1 - 1.4 Printing mode

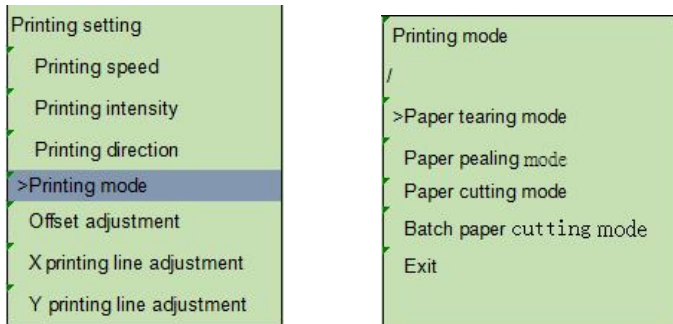

Use this option to set the printout mode of the printer. When entering this option, the icon ">" refers to the mode set currently.

Press FEED to move the cursor.

Press MENU to complete the selection.

Press POWER to cancel the setting and return to the previous menu.

5.1.1 - 1.5 Offset adjustment

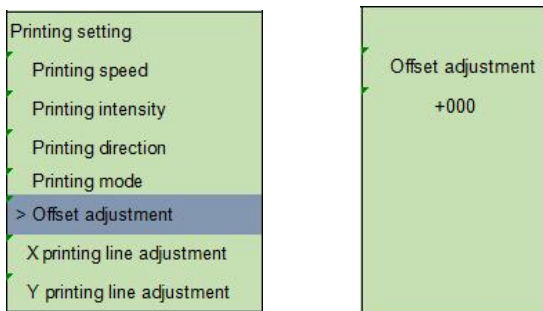

This option can be used to adjust the stop position after the label paper is printed. When the stripping or cutter function is used, it can be used to adjust the stop position of the label; when printing the next label, the compensation can be made for the portion pushed out more or less by means of pulling.

Press MENU to move the cursor to the right side.

Press FEED to set + - or the value from 0 to 9.

Press POWER to cancel the setting and return to the previous menu.

5.1.1 - 1.6 Adjustment of X printing line, adjustment of Y printing line

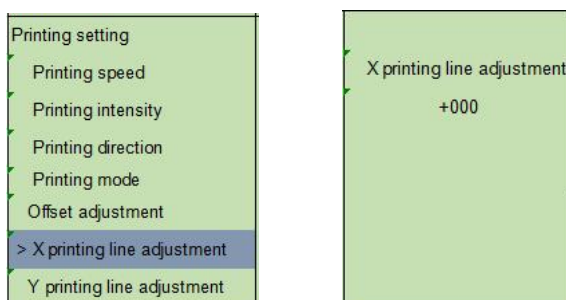

Use this option to adjust the printing position and the stop position of the label.
 Press MENU to move the cursor to the right side.
 Press FEED to set + - or the value from 0 to 9.
 Press POWER to cancel the setting and return to the previous menu.

5.1.1 - 1.7 Reference point

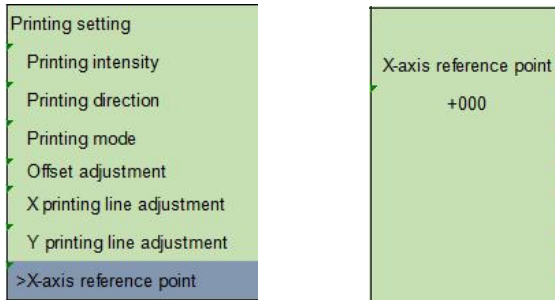

Use this option to adjust the reference coordinates on the label paper relative to the origin point.
 Press MENU to move the cursor to the right side.
 Press FEED to set + - or the value from 0 to 9.
 Press POWER to cancel the setting and return to the previous menu.

5.1.1 - 1.8 Character set

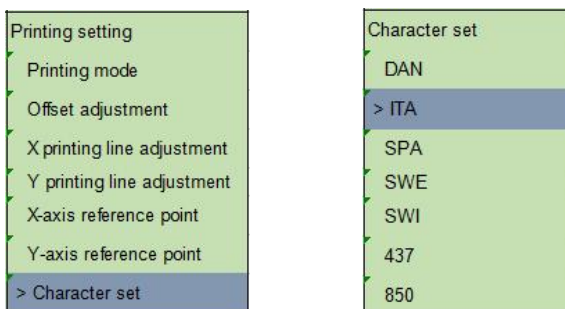

Use this option to set the character set of the printer. When entering this option, the icon ">" refers to the mode set currently.
 Press FEED to select the mode to be set.
 Press MENU to complete the setting.
 Press POWER to cancel the setting and return to the previous menu.

5.1.1 - 1.9 Country code

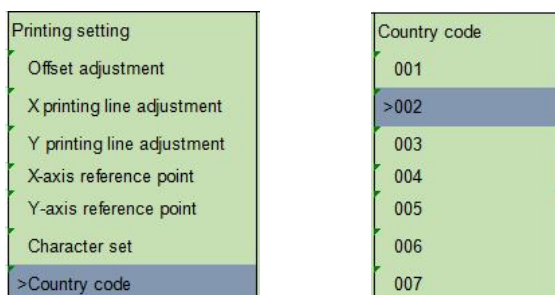

Use this option to set the country code of the printer. When entering this option, the icon “>” refers to the mode set currently.
 Press FEED to select the mode to be set.
 Press MENU to complete the setting.
 Press POWER to cancel the setting and return to the previous menu.

5.1.2 Sensor setting

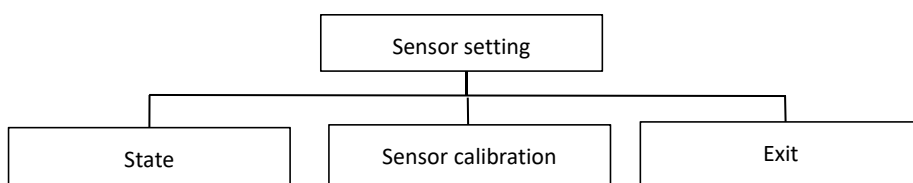

5.1.2.1 Sensor state

Paper length	812
Gap height	24
Sensor intensity	2
Sensor numerical value	Automatic

This option can be used to check the state of printer’s sensor. When entering this option, the following message can be viewed.

5.1.2.2 Sensor calibration

This option can be used to set the detection mode of the sensor according to the label paper to be used and the sensor required for calibration. It is recommended that the sensor shall be recalibrated whenever the label paper is replaced.

A. Gap mode

Sensor correction
>Gap mode
Black mark mode
Continuous paper mode
Exit

Press SCROLL DOWN to select the type of sensor.

Press MENU to complete the setting.
Press POWER to cancel the setting and return to the previous menu.

Automatic gap calibration

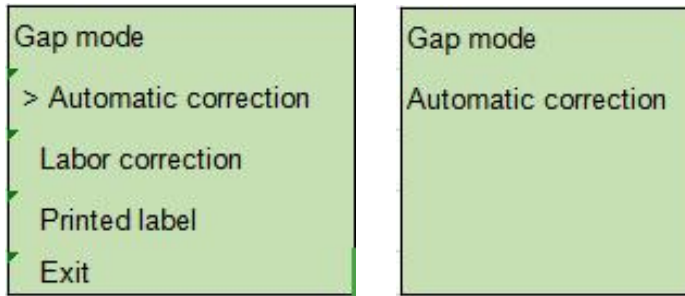

When entering this option, the above message will appear, and the printer will feed 2-3 sheets of label paper for calibration of the sensor. When the calibration is completed, it will return to the previous menu.

B. Black mark mode

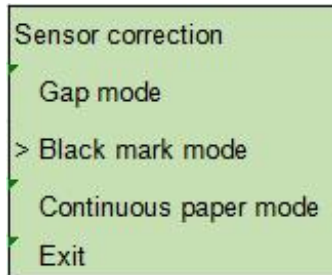

Automatic calibration of black mark



When entering this option, the above message will be displayed on LCD display screen, and the printer will feed 2-3 sheets of paper for calibration of the sensor.

C. Continuous paper mode

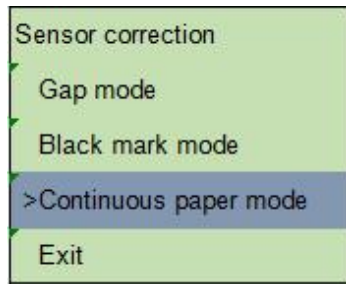

Press SCROLL UP and SCROLL DOWN to select the type of sensor, and press MENU to complete the setting.

Automatic calibration of continuous paper

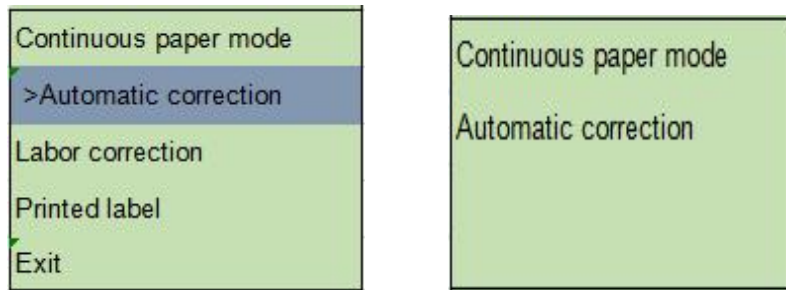

When entering this option, the above message will be viewed, and the printer will automatically calibrate the sensor for the paper. When the calibration is completed, it will return to the previous menu.

5.2 File management

With this option, it is possible to check the usage of the Flash TF memory card of the printer and the management of the files.

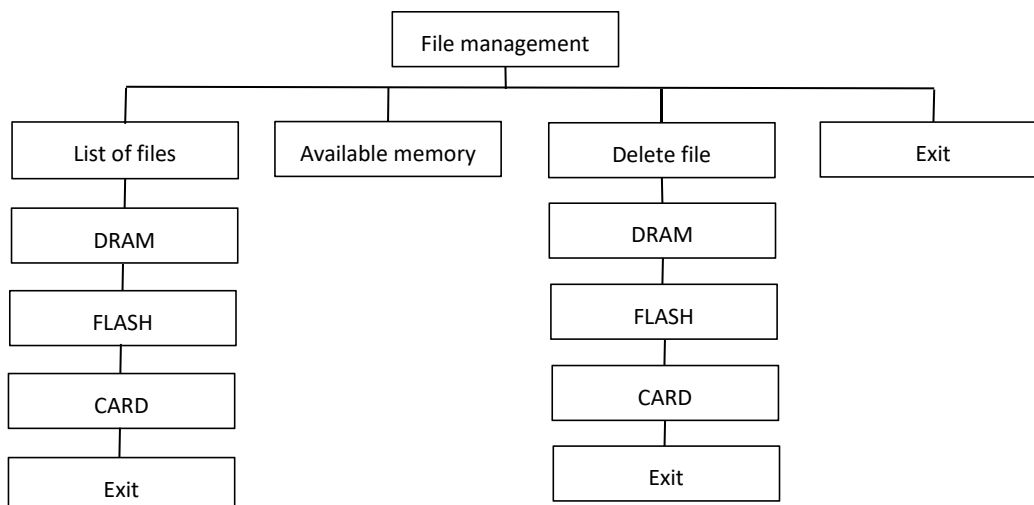

5.2.1 List of files

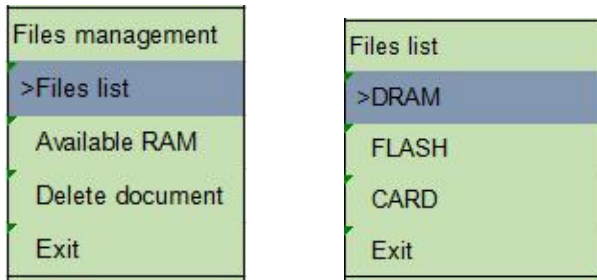

This option can be used to display, delete, and execute (.BAS) the files stored in the memory.

Display of files:

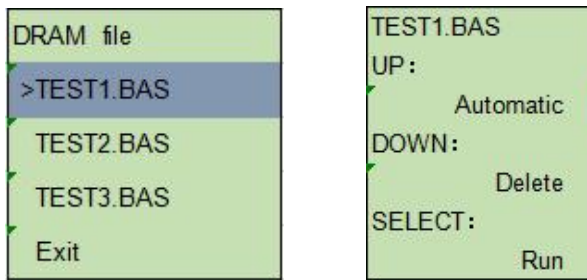

Delete file: Press SCROLL DOWN to delete the file.

Execute file: Press MENU to execute the file.

5.2.2 Memory space

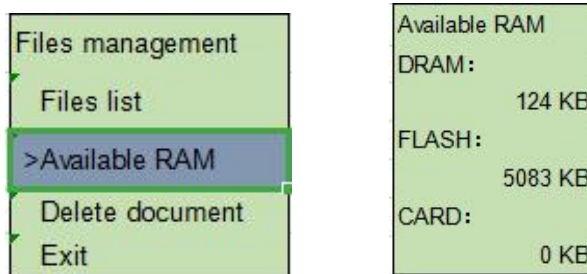

This option can be used to check the residual memory space.

5.2.3 Delete file

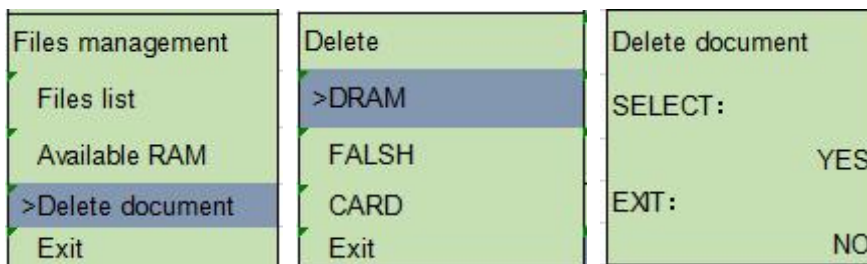

This option can be used to delete the file.

5.3 Printing debugging

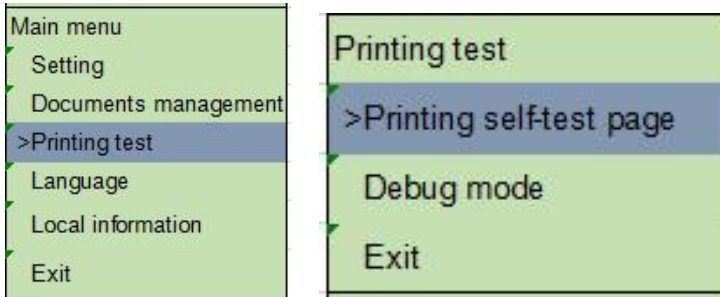
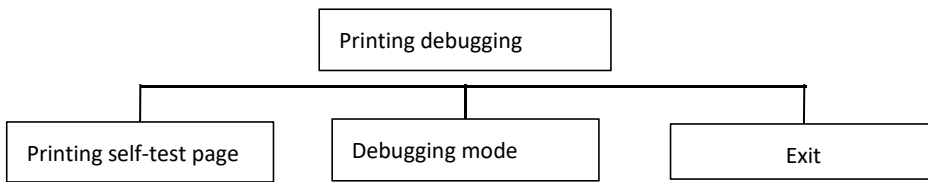

5.3.1 Printing self-test page

After selecting “Printing self-test page”, the printer will automatically print out the internal settings of the printer.

5.3.2 Debugging mode

After this function is selected, the printer will enter the debugging mode.

Note: The “Printing self-test page” and “Debugging mode” are consistent with the functions in the versions without LCD.

5.4 Language

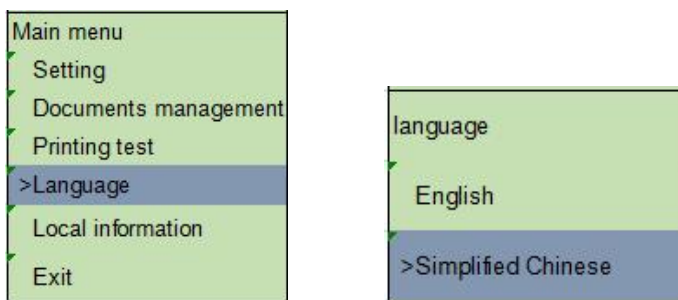
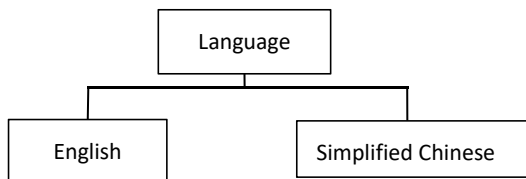

Use this option to set the language to be used for the display screen. When entering this option, the icon “>” refers to the mode set currently. Press FEED to select the mode to be set.

Press MENU to complete the setting.
Press POWER to cancel the setting and return to the previous menu.

5.5 Printer information

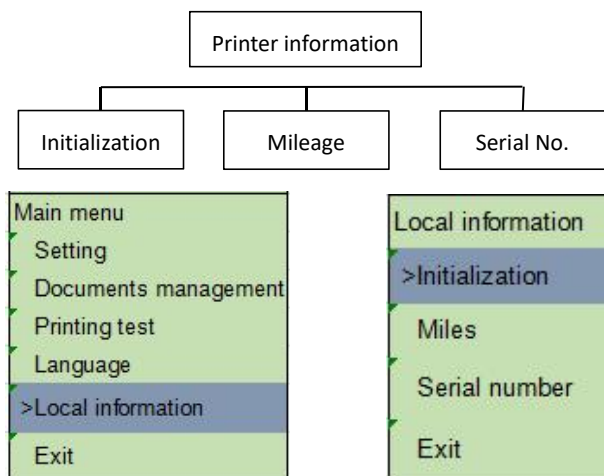

This option can be used to initialize the printer or check the serial number and the mileage printed.

Press FEED to select the mode to be set.
Press MENU to complete the setting.
Press POWER to cancel the setting and return to the previous menu.

VI. Diagnostic Tool

Diagnostic Tool is an easy-to-use window-type utility program that allows you to check the current status and settings of the printer, download graphic files, programs, font files, etc., and complete firmware updates according to the actual need. Moreover, it supports creation and download of dot-matrix fonts, transmission of commands or files and so on. By using it, you can complete the printer setup, check the printer status and troubleshoot the printer usage problems more easily.

6.1 Enable the Diagnostic Tool program

1. Move the mouse cursor to the Diagnostic Tool image  Diagnostic Tool.exe and double click the left mouse button.
2. After it is started, the main screen shows 4 management tabs (printer settings, file management, communication tools, system printer settings).

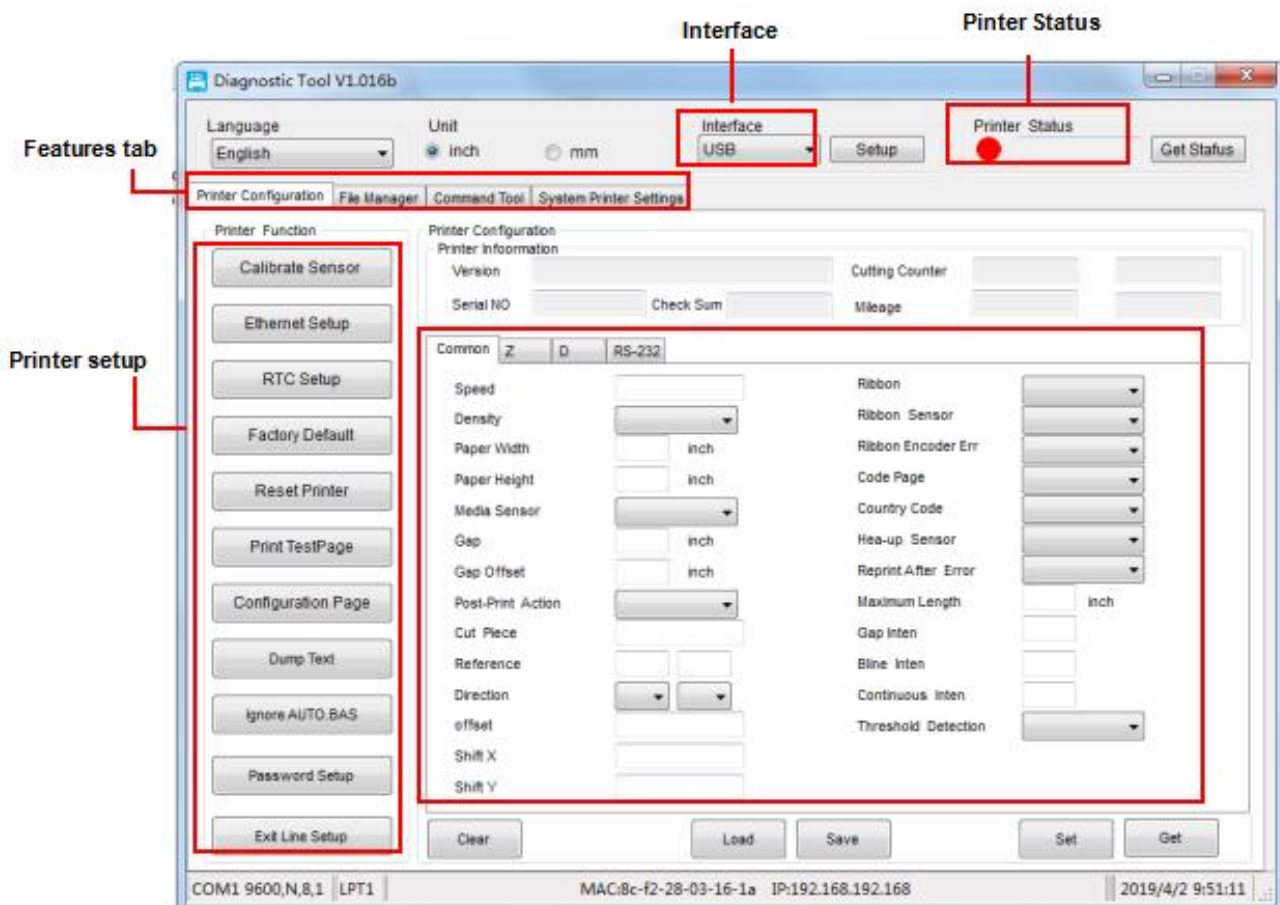

6.2 Printer settings

1. Select the connection interface between your computer and the printer.

Interface
USB Setup

Interface
USB Setup
 COM
 LPT
 ETHERNET
 BT
 WIFI

Cutting Counte

The default communication interface of the Diagnostic Tool program is USB, so if the computer is connected through USB cable for transmission, no changes need to be made to the settings.

2. Click on a function you intend to set in the "Printer Settings".
3. The printer functions in the Printer Settings management page are described as below:

Printer Function	Description
Calibrate Sensor	Sensor Calibration
Ethernet Setup	Set Ethernet Network
RTC Setup	Set Printer RTC Time Parameters
Factory Default	Restore Factory Defaults and Reboot
Reset Printer	Restart the Printer
Print TestPage	Print Test Page
Configuration Page	Print Self-test Page
Dump Text	Enter Printer Debugging Mode
Ignore AUTO.BAS	Ignore the AUTO.BAS File
Password Setup	Set the Diagnostic Tool Password
Exit Line Setup	

6.3 Calibrate the paper sensor with the Diagnostic Tool

6.3.1 Automatic calibration

1. Make sure that the paper is installed correctly and the print head is closed.

Remark: The gap sensor and black mark sensor of the printer are not movable, so as to ensure that the paper gap or black mark passes through the gap sensor or black mark sensor.

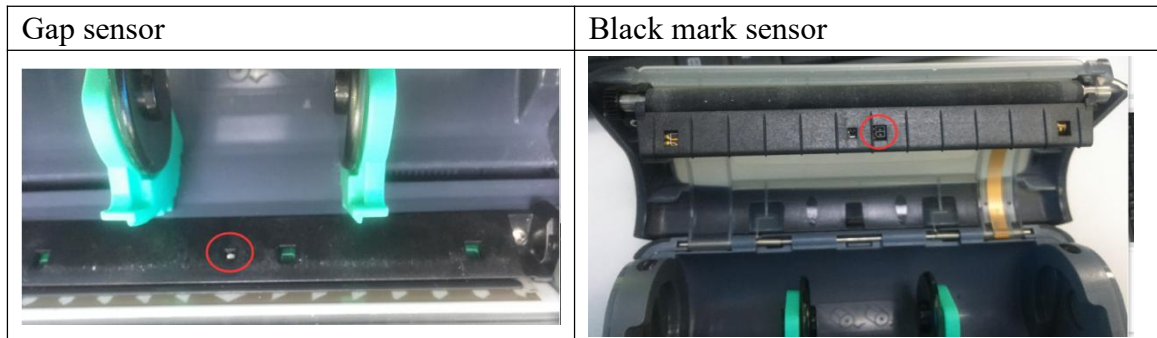

2. Turn on the printer.
3. Start the Diagnostic Tool and set the transmission interface (the default is USB).

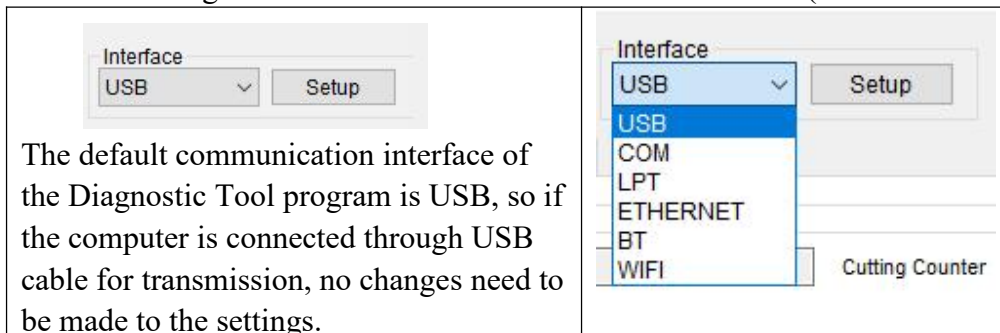

4. Click on "Sensor Calibration".
5. Select the paper type and click on "Calibration". The printer will automatically feed the paper to calibrate the sensor.

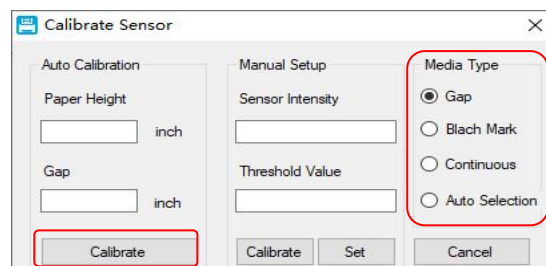

VII. Troubleshooting

7.1 Common problems

The table below shows the common problems the printer operators normally meet and the solutions to them; if you have tried the troubleshooting in the ways we suggest but the printer is still not working properly, please contact the customer service department of the vendor for more assistance.

Problem	Possible cause	Solution
- The power indicator is off.	<ul style="list-style-type: none"> * The AC socket plug and the power supply plug are not properly connected to the socket of the printer. * The printer power is not switched on. 	<ul style="list-style-type: none"> * Check the power connector, and make sure that the AC socket and the power supply plug are properly connected to the printer. * Turn on the power switch.
- The Diagnostic Tool displays "Printer On".	<ul style="list-style-type: none"> * The print head holder is not closed. 	<ul style="list-style-type: none"> * Close the print head holder.
- The Diagnostic Tool displays "Out of Paper".	<ul style="list-style-type: none"> * The label paper is used up. * The volume label installation path is incorrect. * The gap/black mark sensor detection is incorrect. 	<ul style="list-style-type: none"> * Install new label paper. * Refer to the steps of label installation and reinstall it. * Recalibrate the label sensor.
- The Diagnostic Tool displays "Paper Jam".	<ul style="list-style-type: none"> * The gap/black mark sensor detection is incorrect. * The volume label paper size setting is incorrect. * There may be volume label paper stuck inside the printer mechanism. 	<ul style="list-style-type: none"> * Recalibrate the volume label sensor. * Set the correct label size. * Clean the inside of the mechanism.

Problem	Possible cause	Solution
- Unable to print	* Low battery	<ul style="list-style-type: none"> * Check whether the battery has sufficient electricity. * Charge the printer. * Check whether the battery is damaged.
- The memory space is full. (FLASH/DRAM)	*The FLASH/DRAM memory space is full.	<ul style="list-style-type: none"> * Clear unnecessary files inside FLASH/DRAM. * The DRAM can store up to 256 files. * User can store up to 256KB in DRAM. * The FLASH can store up to 256 files. * The maximum a user can store in FLASH is 2560KB.
- Poor printing quality	<ul style="list-style-type: none"> * The label paper is installed incorrectly. * There is dust or adhesive buildup on the print head. * The printing density is not set properly. * The print head is damaged. * The label in use does not match. * The print head pressure setting is inappropriate. 	<ul style="list-style-type: none"> * Reinstall the consumables. * Clean the print head. * Clean the rubber roller. * Adjust the printing density and printing speed of the printer. * Print out the self-test value to check if the print head is damaged. If yes, replace it. * Replace with appropriate label paper. * If the thickness of the label exceeds 0.22 mm, the printing quality may not be good enough. Please increase the print head pressure first. * Make sure that the print head holder is fully closed.
- Paper skip occurs while printing.	<ul style="list-style-type: none"> * The label size setting is incorrect or incomplete. * The label has been changed without recalibrating the sensor. * The label sensor is covered by dust, causing incorrect detection. 	<ul style="list-style-type: none"> * Make sure that the label size setting is correct. * Recalibrate the label sensor. * Remove dust from the sensor with an air brush.

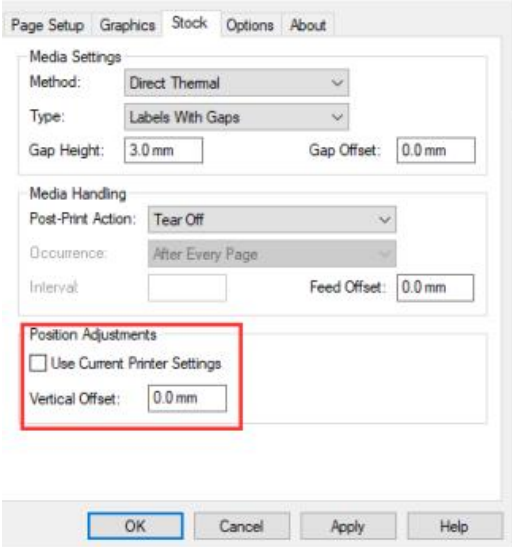
Problem	Possible cause	Solution
<p>- The print position is not correct when printing small volume labels.</p>	<ul style="list-style-type: none"> * The label sensor setting is incorrect. * The label size setting is incorrect. * The vertical offset setting of the volume label style in the printer driver is incorrect. 	<ul style="list-style-type: none"> * Recalibrate the label sensor. * Set the correct volume label size and volume label gap size. * If the BarTender software is used, set the vertical offset in the printer driver. 
<p>- Print missing on both left and right sides.</p>	<ul style="list-style-type: none"> * The label size setting is incorrect. 	<ul style="list-style-type: none"> * Set the correct label size.
<p>- The RTC time is not correct after restarting the printer.</p>	<ul style="list-style-type: none"> * The battery is dead. 	<ul style="list-style-type: none"> * Check the battery on the main board.
<p>- Gray lines appear on black label paper.</p>	<ul style="list-style-type: none"> * There is dirt on the print head. * There is dirt on the rubber roller. 	<ul style="list-style-type: none"> * Clean the print head. * Clean the rubber roller.
<p>- Unstable printing</p>	<ul style="list-style-type: none"> * The printer is in the Hex Dump mode. 	<ul style="list-style-type: none"> * Turn the printer off and on again to jump out of the Dump mode.

VIII. Simple Maintenance of the Printer

The simple maintenance procedures aim to ensure the printing quality and extend the life of the printer. Below are some of our recommended maintenance procedures.

1. Clean and maintain your printer by using the tools listed below:

Cotton swab

Cotton cloth

Vacuum cleaner or air brush

Medical alcohol

2. Cleaning steps:

Item	Steps	Recommended frequency
Print head	<ol style="list-style-type: none"> 1. Turn off the printer. 2. Allow the print head to cool for at least one minute. 3. Wipe the print head surface with a cotton swab dipped in medical alcohol. 	When installing a new roll of label paper
		
Rubber roller	<ol style="list-style-type: none"> 1. Turn off the printer. 2. While rotating the rubber roller, carefully wipe it with a cotton cloth or cotton swab dipped in medical alcohol. 	When installing a new roll of label paper
Paper tearing-off piece	Wipe it with a cotton cloth dipped in medical alcohol.	When needed
Sensor	Remove dust from the sensor with an air brush or vacuum cleaner.	Monthly
Outside of the machine	Wipe it with a wet cotton cloth.	When needed
Inside of the machine	Remove dust from inside of the machine with an air brush or vacuum cleaner.	When needed

Note:

Do not touch the print head directly by hand. If your hand touches it accidentally, wipe it with a cotton swab dipped in medical alcohol.

Use medical alcohol. Do not use industrial alcohol, which may damage the print head.

If your printer displays error messages frequently, clean the sensor of the printer regularly.

The equipment can be used safely in tropical climates.

This is a Class A product that may cause radio interference in a living environment. In

such case, users may need to take practical measures accordingly.

Update history

Date	Content	Editor
July 8, 2019	Issue	Gzs